

ISTRUZIONI DI MONTAGGIO - NOTICE DE MONTAGE - ASSEMBLY INSTRUCTIONS

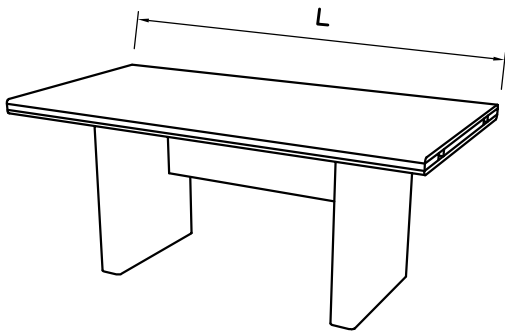

35001 L=180 cm  
35002 L=210 cm

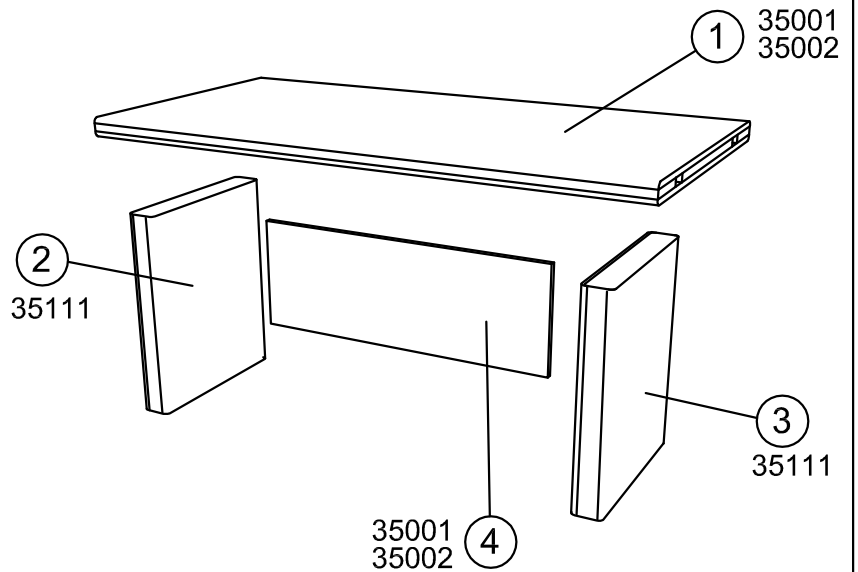

utensili necessari  
outils nécessaires  
tools required

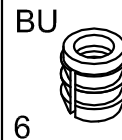
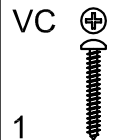
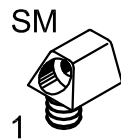
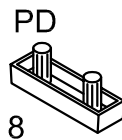
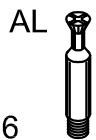
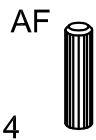
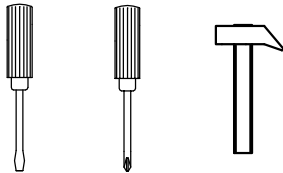

NOTES

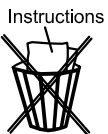
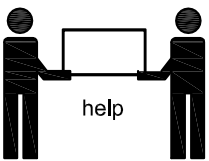
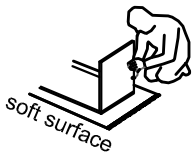

(IT) **Usare il prodotto in modo corretto**, esclusivamente per la funzione a cui è destinato.  
Per spostarlo, sollevare e non trascinare.

(FR) **Utilisez le produit correctement**, exclusivement pour la fonction à laquelle il est destiné.  
Pour le déplacer, soulevez et ne traînez pas.

(EN) **Use the product correctly**, exclusively for the function for which it is intended.  
To move it, lift and not drag.

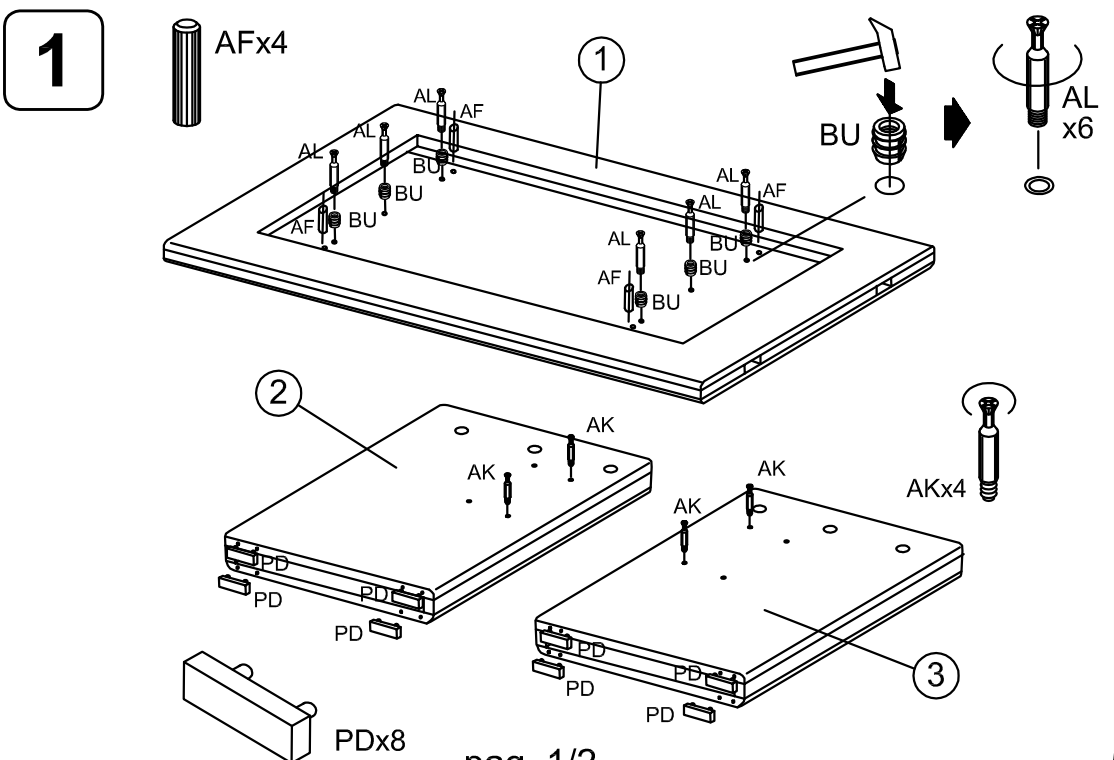

2

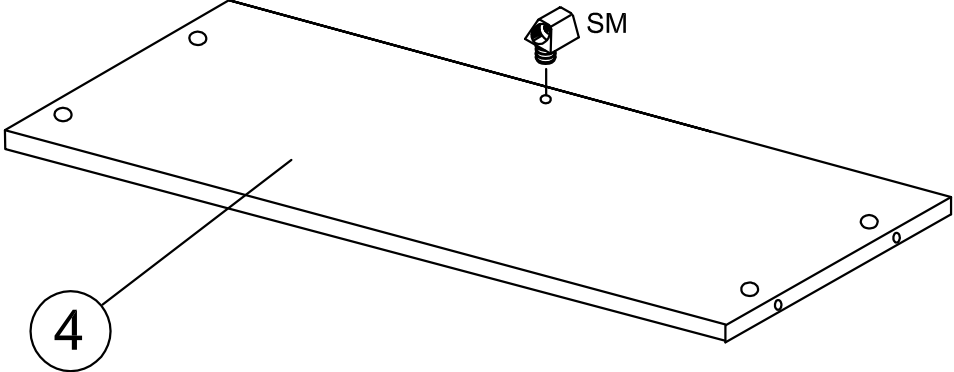
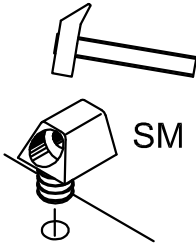

3

